

EASY
HOME®

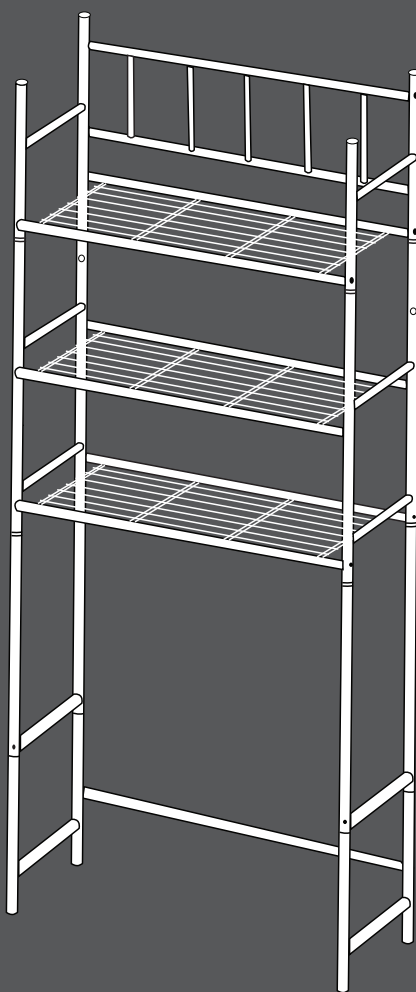

ASSEMBLY INSTRUCTIONS

BATHROOM SPACE SAVER SHELF



64.5 H X 23 W X 10 D IN

(164 H x 58 W x 25 D CM)

BATHROOM

AFTER SALES SUPPORT



 (USA) 877 282 6195



MODEL: 45410

2

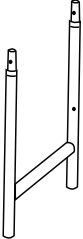
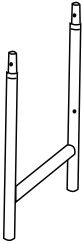
YEAR WARRANTY

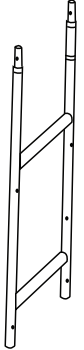
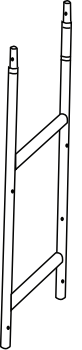
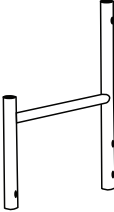
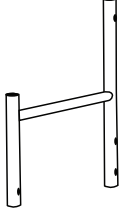
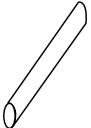
Parts List

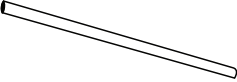
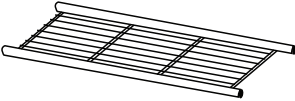
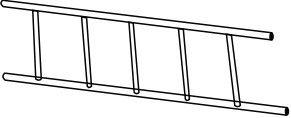
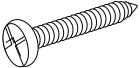
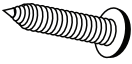
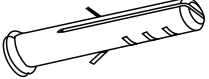
A 1PC	B 1PC	C 4PCS	D 1PC	E 1PC	F 1PC	G 1PC	H 2PCS
							

I: 1PC	J: 3PCS	K: 1PC
		
L: 22PCS	M: 2PCS	N: 2PCS
		
Tools Required: Phillips Screwdriver 		

**** Do not fully tighten the unit until completely assembled. Once completely assembled check each screw to ensure that they are tightened. Double check all screws a 2nd time.

Assembly

STEP 1

Begin by placing part (I) between parts (A) and (B). Use 2 screws (L) and tighten. Take all 4 pcs of part (C) and place onto part (A) and (B).

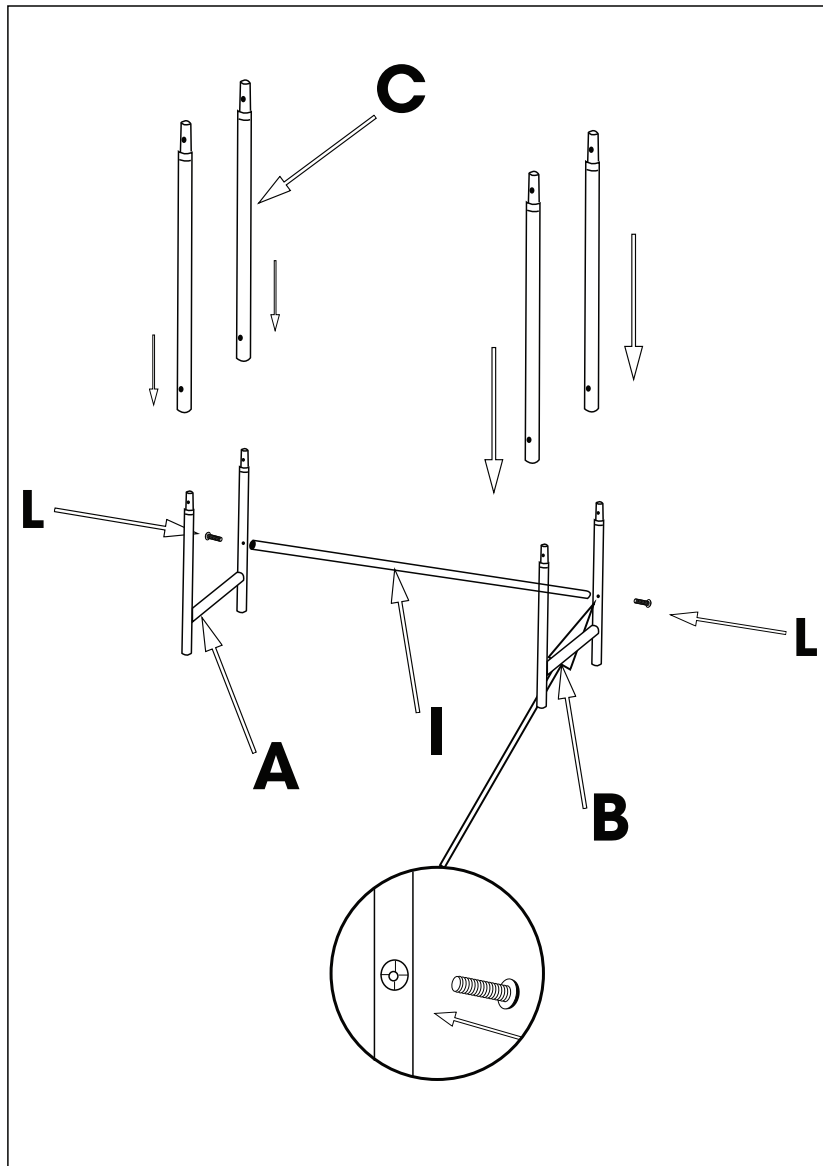

Figure 1

3

Assembly

STEP 2

Place part (H) between parts (C). Use screws (L) and tighten. Repeat this step on the other side. Take part (D) and place onto parts (C). Then, take part (E) and place onto parts (C). There is 1 extra hole on top of each part (D) and (E). Make sure these are on the same side that part (I) is on. This will become the back side of the unit. Next, using 4 screws (L) tighten part (J) between the lower section of parts (D) and (E). Repeat this step with the next shelf by using 4 screws (L) and tighten part (J) between the upper section of parts (D) and (E).

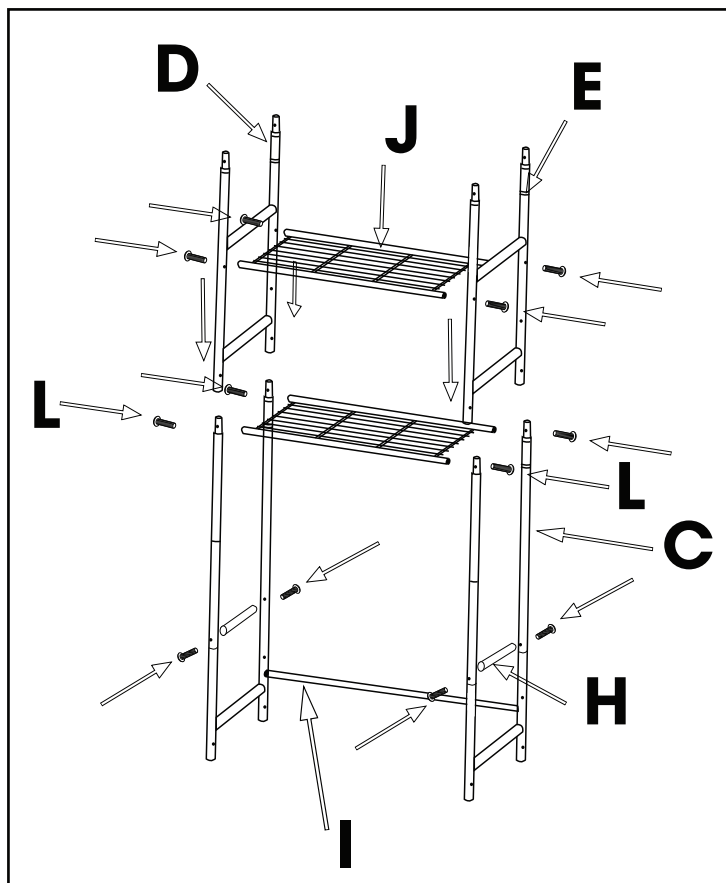

Figure 2

4

Assembly

STEP 3

Take part (F) and place onto part (D). Then, take part (G) and place onto parts (E). Next, using 4 screws (L) tighten part (J) between parts (F) and (G). Then, using 4 screws (L) tighten part (K) between parts (F) and (G). Now that the unit is set-up tighten all the screws (L). Double check all the screws (L) a 2nd time.

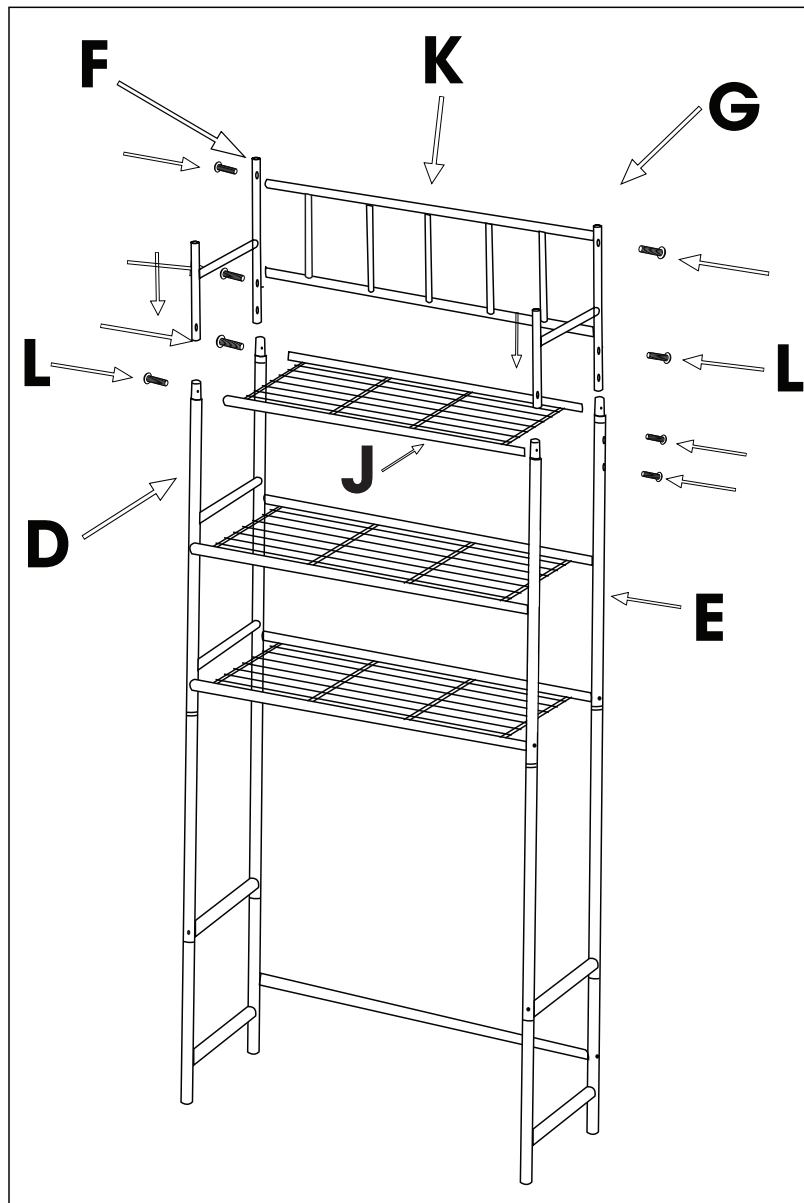

Figure 3

5

Assembly

STEP 4

The last step is securing your unit to the wall. Place the unit against the wall and measure where the holes line up from the unit to the wall. You can leave a mark on your wall with part (M) or by using a pencil. Next, drill a small hole that is just large enough for part (N) to fit. Gently hammer part (N) into the wall until it is flush with the wall. Next, take parts (M) place them into the 2 remaining holes on parts (D) and (E). These holes will line up with parts (N) which are already placed into the wall. Next, screw parts (M) into parts (N).

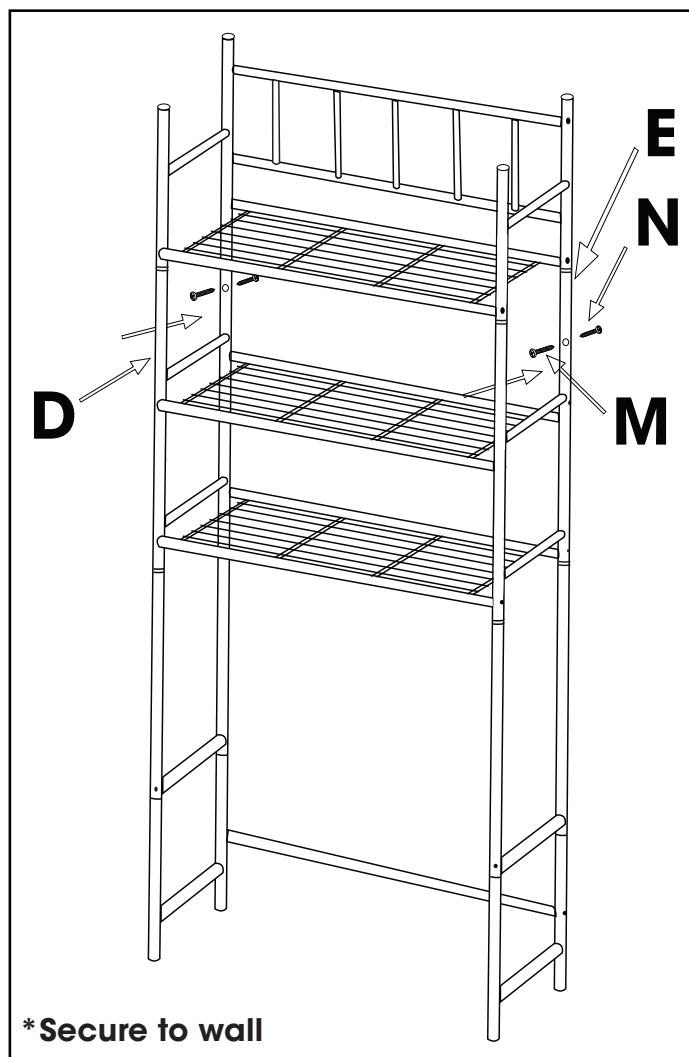

Figure 4

6

Warning

We want you to be completely satisfied with your purchase, so this EASY HOME product is backed by a comprehensive manufacturer's 2 year warranty.

If you require technical support or in the unlikely event that your purchase is faulty please telephone our Helpline for immediate assistance. Faulty product claims made within the 2 year warranty period will be repaired or replaced free of charge.

IMPORTANT! Please read prior to use.

This space saver is designed for indoor use. Please do not overload. We recommend that you secure space saver unit to a wall. Space saver unit must be secured to a wall if there are children present in order to prevent accidental tipping which can cause serious injury. Please do not use shelving unit for anything other than its intended use.

2 YEAR LIMITED WARRANTY

The manufacturer warrants this product will be free from defects in materials and workmanship when used for normal personal or household use, except as provided below. The manufacturer, at its option, may offer a comparable product or offer a replacement part or request that the item be returned to the place of purchase. This warranty DOES NOT apply to damage caused by negligence, misuse, excessive use, improper cleaning, improper assembly, or any circumstances not directly attributable to manufacturing defects. Proof of purchase is required in the form of a receipt (copy or original) to validate warranty. This limited 2 year warranty is offered in lieu of all other warranties, either expressed or implied. In no event shall the manufacturer, its affiliates, or subsidiaries be responsible for consequential or incidental damages arising out of a claim of defective product. Some states or provinces do not allow some exclusions or limitations, so the above statement may not apply to you. This warranty gives you specific legal rights. Additional rights vary by state or province.

WARNING: Keep bags and plastic sheeting away from babies and children. Do not use in cribs, beds, carriages, or playpens. The plastic may cling to the nose and mouth and prevent breathing.