



Infrared quartz heater

User manual



English.....2

AFTER SALES SUPPORT



USA

888 775 0202



cshelp@mcappliance.com

MODEL: EHQH15W PRODUCT CODE: 40186-14 12/2014

Introduction

Congratulations!

You have made an excellent choice with the purchase of this quality Easy Home product. By doing so you now have the assurance and peace of mind which comes from purchasing a product that has been manufactured to the highest standards of performance and safety, supported by the high quality standards of ALDI.

We want you to be completely satisfied with your purchase so this Easy Home product is backed by a comprehensive manufacturer's 2-year warranty and an outstanding after sales service through our dedicated After Sales Support.

We hope you will enjoy using your purchase for many years to come.

If you require technical support or in the unlikely event that your purchase is faulty, please telephone our After Sales Support for immediate assistance. Faulty product claims made within the 2-year warranty period will be repaired or replaced free of charge provided that you have satisfactory proof of purchase (keep your receipt). This guarantee is in addition to your statutory rights. Your statutory rights are not affected. This limited warranty does not apply in cases of damage caused by accident, improper use, abuse or force majeure.

This limited warranty will be invalidated if the appliance is tampered with in any way whatsoever. In case of questions or technical problems, please call the following toll-free After Sales Support number: 1-888-775-0202, Monday to Friday 8:30am to 8:00pm ET.

If the appliance has to be returned to us, it must be packed correctly as we cannot accept any responsibility for damage caused in transit.

Certifications

The ETL Listed Mark is proof that your product has been independently tested and meets the applicable published safety standard.



Publisher of the User Manual

MC Appliance Corporation
940 N. Central Ave. Wood Dale, IL 60191
cshelp@mcappliance.com

Manufacturer of the Infrared Quartz Heater

MC Appliance Corporation
940 N. Central Ave. Wood Dale, IL 60191
cshelp@mcappliance.com

Product Components

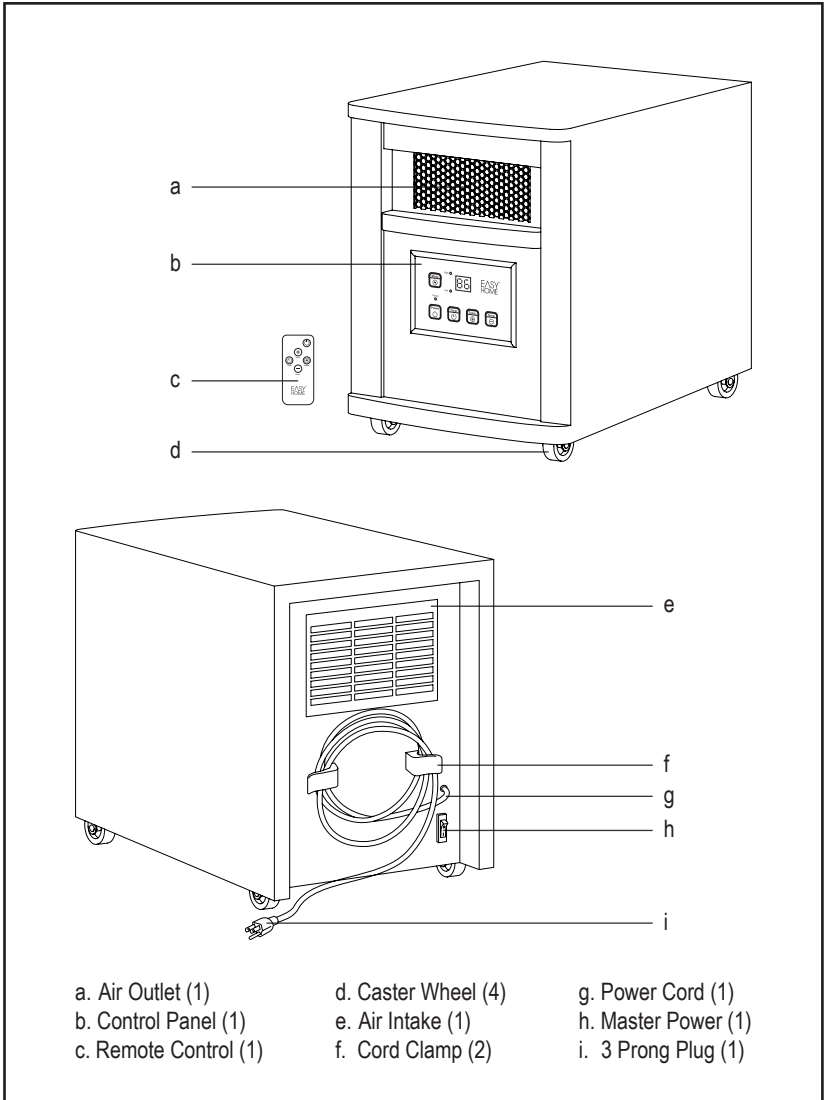

Table of Contents

- 05 Chapter 1 - General Information
 - 05 Use and Storage of the User Manual
 - 05 Intended Use
 - 05 Emphasis Used
- 06 Chapter 2 - Safety
 - 06 Explanation of Symbols
 - 06 Electric Power
 - 06 3 Prong Grounding Plug
 - 07 Important Safety Instructions
- 09 Chapter 3 - Installation
 - 09 Unit
 - 09 Remote Control
- 10 Chapter 4 - Use
 - 10 Control Panel
 - 10 Remote Control
 - 11 Before Use
 - 11 Operation
 - 11 Setting the Power Off Timer Function
 - 12 Setting the Power On Timer Function
- 13 Chapter 5 - FAQ
 - 13 Troubleshooting
 - 13 Cleaning
 - 13 Maintenance and Storage
 - 14 Technical Data
 - 14 Environmental Protection
- 15 Warranty Conditions
 - 15 Limited Warranty
 - 15 Limitations of Remedies and Exclusions
- 17 Warranty Card

General Information

Use and Storage of the User Manual

Inside this user manual you will find information on how to use and maintain your Infrared Quartz Heater properly, including but not limited to, safety instructions and precautions, installation and use instructions, frequently asked questions, and warranty conditions. Please store this user manual in an easily-accessible location for future reference.

Intended Use

Your Infrared Quartz Heater has been designed as a home environment heating appliance as described in this user manual. Do not use this appliance for any other purpose. This product is intended for household use only. The heater comes equipped with a two-year parts and labor warranty. Please contact our After Sales Support team toll-free at 1-888-775-0202 for more information or to request warranty service.

Emphasis Used

Words in *italic* refer to buttons on the control panel.

Safety

Explanation of Symbols

Recognize these symbols:

WARNING

Hazards or unsafe practices which COULD result in severe personal injury or death.

CAUTION

Hazards or unsafe practices which COULD result in minor personal injury.

THIS PRODUCT IS INTENDED FOR HOUSEHOLD USE ONLY

WARNING

Read and understand all safety precautions. Failure to follow all instructions described in this user manual may result in electric shock, fire and/or serious personal injury. The warnings, cautions and instructions discussed in this user manual cannot cover all possible conditions and situations that may occur. It must be understood by the user that common sense and caution are attributes which cannot be built into the appliance, but must be supplied by the user.

Electric Power

If an electric circuit is overloaded with other appliances, the Infrared Quartz Heater may not operate properly. The heater should be operated on a separate electrical circuit from other operating appliances.

3 Prong Grounding Plug

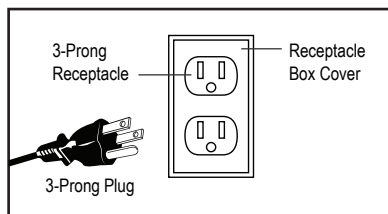

This appliance must be grounded. In the event of an electrical short circuit, the grounding plug reduces the risk of electric shock by providing an escape wire for electric current. This appliance is equipped with a power cord that has a grounding wire with a grounding plug. The plug must be plugged into an electrical outlet that is properly installed and grounded.

This appliance requires a standard 120V AC, 60Hz electrical outlet with a 3-prong ground receptacle. To prevent accidental injury, the cord should be secured behind the appliance and not left exposed or dangling.

⚠ WARNING

Improper use of the grounding plug and/or outlet can result in a risk of electric shock. Consult a qualified electrician or serviceman if the grounding instructions are not completely understood or if doubt exists as to whether the appliance is properly grounded. If it is necessary to use an extension cord, use only a 3-wire extension cord that has a 3-blade grounding plug, and a 3-slot receptacle that will accept the plug on the appliance. The marked rating of the extension cord shall be equal to or greater than the electrical rating of the appliance. If the power supply cord is too short, have a qualified electrician or serviceman install an outlet near the appliance.

⚠ WARNING

DO NOT cut or remove the third (ground) prong from the power cord under any circumstances.

Important Safety Instructions

When using any electric appliance, some basic safety precautions should always be followed to reduce the risk of fire, electric shock and/or injury, including the following:

1. Read all instructions carefully before operating the unit.
2. This heater gets very hot when in use. To avoid burns, DO NOT let bare skin touch surfaces.
3. Keep all flammable materials such as furniture, pillows, bedding, paper, clothing, and curtains at least 3 feet from the front and top of the appliance. Also be sure to prevent contact with the sides and back of the unit.
4. DO NOT place the heater near a bed. Objects such as pillows or blankets may fall off the bed and be ignited by the heater.
5. This appliance is not intended for use by children or people with reduced physical, sensory, or mental capabilities. Children should be supervised to ensure that they do not play with the appliance.
6. DO NOT operate the unit with a damaged cord or when it has been dropped or damaged in any way.
7. To completely turn off the unit, push the power button and then unplug the heater. Pull firmly on the plug; DO NOT unplug by pulling on the cord.
8. Always disconnect the plug from the power outlet when the unit is not in use.
9. DO NOT wrap the cord around the unit immediately after use.
10. DO NOT use this unit outdoors.
11. This heater is not intended for use in a bathroom, laundry area or similar indoor location. Never position the unit where it may come in contact with water.
12. DO NOT run the power cord under carpeting. DO NOT cover the cord with throw rugs, runners or similar coverings. Keep the cord away from any place where it could be tripped over.

13. DO NOT insert foreign objects into the air intake or air outlet, as this may cause electrical shock, fire or damage to the unit.
14. To prevent a possible fire, DO NOT block the air intake or air outlet in any way. DO NOT use the unit on soft surfaces, such as a bed, where the openings may become blocked. Always use on a dry level surface. Only use the heater on the floor.
15. In order to prevent overheating and the risk of fire, DO NOT cover the appliance while it is functioning.
16. The internal parts of the heater become very hot and cause sparking spots inside during operation. DO NOT use this unit in an area where gasoline, paints or other flammable liquids are used or stored. Keep this unit away from heated surfaces and open flames.
17. Use this heater only as described in this manual. Any other use not indicated by the manufacturer may result in fire, electric shock or injury. The use of attachments not recommended or sold by the manufacturer may result in fire, electric shock or injury.
18. Ensure no other appliance is plugged into the same outlet or into another outlet wired into the circuit.
19. It is normal for the plug and cord to feel warm to the touch. An excessively hot or deformed plug or cord is not normal and may be the result of a defective electrical outlet. Defective outlets must be replaced before using the heater. Plugging the heater into a worn outlet may result in overheating of the power cord or may cause a fire. Make sure that the plug is fully inserted into the outlet. Wall outlets may deteriorate in time so check the plug periodically for signs of overheating. Check that neither the appliance nor the power cords have been damaged during shipping.
20. DO NOT attempt to repair or adjust any electrical or mechanical malfunction on this unit; doing so will void your warranty. Only a service agent or licensed and qualified professional should perform any servicing.
21. DO NOT use this appliance with an extension cord or outlet strip. Connect the appliance directly to a properly grounded outlet.
22. Make sure that there is no styrofoam or other packaging material remaining in the unit.
23. The first time the heater is used, run it at the maximum power for at least two hours. During this time, ventilate the room thoroughly to eliminate the new smell released by the unit. It is completely normal for the unit to emit cracking sounds the first time it is used.
24. Use extreme caution whenever the heater is left operating unattended.
25. DO NOT open the unit. The heater contains no user serviceable parts inside.

Installation

Unit

CAUTION

DO NOT attempt to open this unit. There are no user-servicable parts inside.

Remote Control

When using the remote control, please pull out the battery saving insulating film.

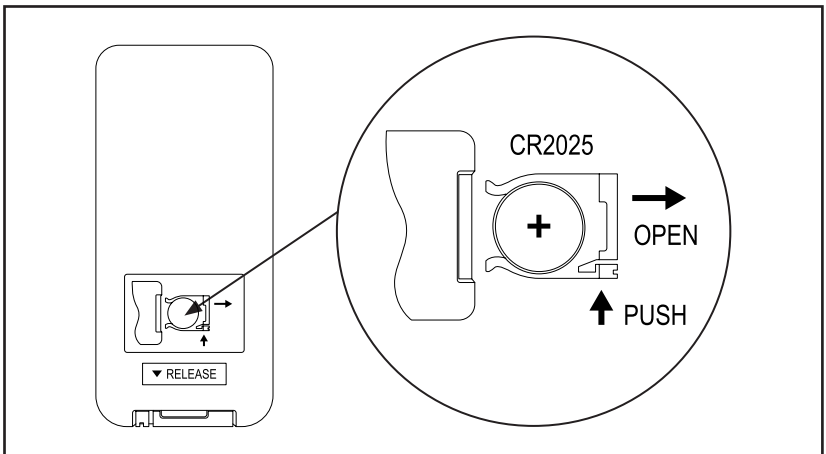

To change the battery:

1. Release the battery holder out from the remote control according to the illustration on the back of the remote control.
2. Dispose of the used battery properly.
3. Put the new battery into the battery holder.
4. Push the battery holder back into the remote control.

Use

Control Panel

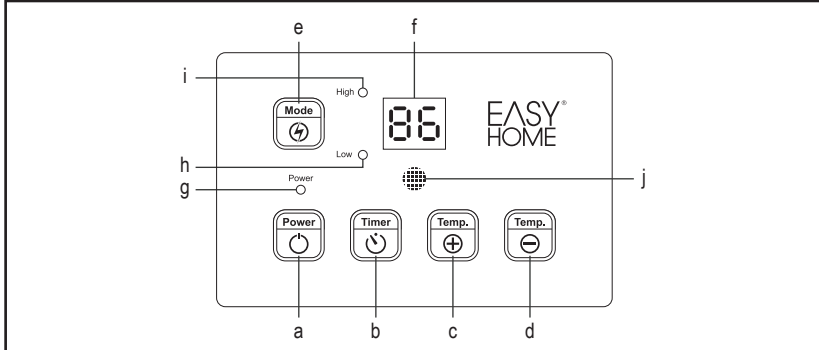

- Power button:** Powers the heater "On" and "Off".
- Timer button:** Used to engage timer mode and to set the hour value for the timer.
- Temp. + button:** To increase desired temperature.
- Temp. - button:** To decrease desired temperature.
- Mode button:** To select between "Low" and "High" heat modes.
- Digital display:** Indicates set room temperature or time.
- Power indicator light:** Will be lit when the unit is powered "On".
- Low Mode indicator light:** Will be lit when "Low" heat mode is engaged.
- High Mode indicator light:** Will be lit when "High" heat mode is engaged.
- Signal receiving window:** For receiving remote control signal.

Remote Control

- Power button:** Powers the heater "On" and "Off".
- Timer button:** Used to engage "Timer" mode and to set hour value for the timer.
- Temp. + button:** To increase desired temperature.
- Temp. - button:** To decrease desired temperature.
- Mode button:** To select between "Low" and "High" heat modes.

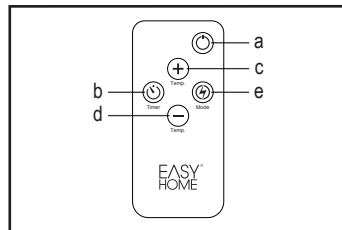



















Before Use

Carefully remove your heater from the box. Save the carton for off-season storage. Put the heater on a flat and stable surface. Make sure the unit is in the off position before plugging the heater into the outlet. Plug the cord into a 120V AC/60Hz electric outlet. Only operate the heater in an upright position with caster wheels attached.

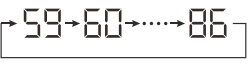
Operation



The master power switch is located at the back of the unit. This must be turned on for the unit to function. When this is in the off position, zero power will be supplied to the unit.



Description	Button to Use	Indicator
Turn the heater on by pressing the <i>Power</i> button on the control panel or remote control.	 	Power  → Power 
Press the <i>Mode</i> button to choose between two heat modes. High mode uses 1500W, Low mode uses 1000W.	 	High  → High  Low  → Low 
Adjust the desired temperature by pressing the <i>Temp. +/Temp. -</i> buttons on the control panel or remote control.	   	
Turn the heater off by pressing the <i>Power</i> button on the control panel or remote control.	 	Power  → Power 

NOTE: Once the unit has been turned off, the heating element will stop working. However, the fan will continue working to cool down the heating element. The digital display will show a 60 second countdown. This is normal and you do not need to take any further action. **DO NOT** turn the master power switch (located at the back of the unit) to the off position during this time.

Setting the Power Off Timer Function



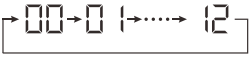

NOTE: The power "Off" timer function can only be set while the heaters display is in the "on" position.

Description	Button to Use	Indicator
Turn the heater to the "On" position. Press the timer button on the heater's control panel or on the remote control. The digital display will change from the "temperature" to the "hours" option for the timer.	 	86-00

<p>Continue to press the timer button to change the number of hours you would like the heater to run before powering itself off. The hour options for the timer are from 0 to 12 hours in one hour increments.</p>		
<p>The number of hours selected will flash for a few seconds, and then revert back to the set desired temperature. The heater will power "Off" when the internal heater clock counts down the number of hours you set.</p>		

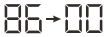
Setting the Power On Timer Function

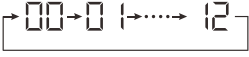
NOTE: The Power "On" timer function will allow for the heater to power "On" after a certain set time, and can only be set while the heater's display is in the "Off" position.

Description	Button to Use	Indicator
<p>Turn the heater to the "Off" position. Press the timer button on the heater's control panel or the remote control. The digital display will change from the "temperature" to the "hours" option for the timer.</p>		
<p>The digital display shows the hours option for the timer. Continue to press the timer button to change the number of hours you would like the heater's internal clock to count down before powering itself on. The hour options for the timer are from 0-12 hours in one hour increments.</p>		
<p>The heater will power itself on when the internal heater clock counts down the number of hours you set.</p>		

FAQ

Troubleshooting

Problem	Solutions
Will not operate or turn on	<ul style="list-style-type: none"> - Unplug the unit and make sure the heater is placed in an upright position. - Check for obstructions. If you find an obstruction, turn the heater OFF and unplug the unit. Carefully remove the obstruction. - Make sure Mode Control is on the Low or High setting. * DO NOT attempt to open or repair the heater.

Cleaning

- It is recommended to clean the unit at least once a month and before off-season storage.
- Before cleaning, be sure the unit is turned off and unplugged.
- Clean the heater with a vacuum brush; this will remove lint and dirt from the inside of the heater.
- DO NOT immerse the heater in water.
- Never use gasoline, benzene or thinner. This will damage the surface of the heater.
- To clean external surfaces, only use a dry cloth. DO NOT use water, polish or any chemical solution.

Maintenance and Storage

- Store the heater in a cool and dry location with power cord properly secured.
- Please store the unit in its original carton or other suitable container.
- Turn the power switch in the back of the unit off.
- Unplug the unit and let it cool completely.
- If you do not use the heater for long periods of time, please take out the remote batteries. Store the batteries in a safe place.

Technical Data

Voltage Rating	120V AC
Power Rating	1500 Watts
Capacity	1000 Sq. Ft.
Product Dimensions	15.5" x 12.0" x 15.8" [W x H x D] (394 mm x 305 mm x 401 mm [An x Al x P])
Net Weight	21.4 Lbs. (9.7 Kg)

Environmental Protection

If the appliance should no longer work, please make sure it is disposed of in an environmentally friendly way.



Warranty Conditions

Limited Warranty

MC Appliance Corporation warrants each new Infrared Quartz Heater to be free from defects in material and workmanship and agrees to remedy any such defect or to furnish a new part(s) (at the company's option) for any part(s) of the unit that has failed during the warranty period. Parts and labor expenses are covered on this unit for a period of two years after the date of purchase. A copy of the dated sales receipt/invoice is required to receive warranty service, replacement or refund.

This warranty covers appliances in use within the contiguous United States, Alaska, Hawaii and Puerto Rico. The warranty does not cover the following:

- Damages due to shipping damage or improper installation
- Damages due to misuse or abuse
- Content losses due to failure of the unit
- Repairs performed by unauthorized service agents
- Service calls that do not involve defects in material and workmanship such as instruction on proper use of the product or improper installation
- Replacement or resetting of house fuses or circuit breakers
- Failure of this product if used in ways other than its intended purpose
- Disposal costs for any failed unit(s) not returned to our factory
- Any delivery or installation costs incurred as the result of a unit that fails to perform as specified
- Expenses for travel and transportation for product service if your appliance is located in a remote area where service by an authorized service technician is not available
- The removal and reinstallation of your appliance if it is installed in an inaccessible location or is not installed in accordance with published installation instructions
- Refunds for non-repairable products are limited to the price paid for the unit per the sales receipt.
- This warranty is non-transferable. This warranty applies only to the original purchaser and does not extend to any subsequent owner(s).

Limitations of Remedies and Exclusions

Product repair in accordance with the terms herein, is your sole and exclusive remedy under this limited warranty. Any and all implied warranties including merchantability and fitness for a particular purpose are hereby limited to one year or the shortest period allowed by law. MC Appliance Corporation is not liable for incidental or consequential damages and no representative or person is authorized to assume for us any other liability in connection with

the sale of this product. Under no circumstances is the consumer permitted to return this unit to the factory without the prior written consent of MC Appliance Corporation.

Some states prohibit the exclusion or limitation of incidental or consequential damages, or limitations on implied warranties. This warranty gives you specific legal rights, and you may also have other rights which vary from state to state.

Model		Parts & Labor	Type of Service
EHQH15W		Two Years	Carry-In

For service or assistance, please call 888-775-0202. Or visit us on the web at www.mcappliance.com to request warranty service or order parts.

WARRANTY CARD

INFRARED QUARTZ HEATER

Your details:

Name _____

Address _____



_____ E mail _____

Date of purchase* _____

* We recommend you keep the receipt with this warranty card

Location of purchase _____

Description of malfunction:



Return your completed warranty card to:

MC Appliance
940 N. Central Avenue
Wood Dale, IL
60191
USA
cshelp@mcappliance.com

AFTER SALES SUPPORT

 USA 888 775 0202  cshelp@mcappliance.com

MODEL: EHQH15W PRODUCT CODE: 40186-14 11/2014

Phone lines available
Mon to Fri, 8:30am - 8:00pm ET

2

YEAR WARRANTY

Warranty Conditions

Dear Customer,

The **ALDI warranty** offers you extensive benefits compared to the statutory obligation arising from a warranty:

Warranty period: **2 years** from date of purchase.
6 months for wear parts and consumables under normal and proper conditions of use (e.g. rechargeable batteries).

Costs: Free repair/exchange or refund.
No transport costs.

ADVICE:	Please contact our service hotline by phone, e-mail or fax before sending in the device. This allows us to provide support in the event of possible operator errors.
----------------	--

In order to make a claim under the warranty, please send us:

The original receipt and the warranty card properly completed

The product with all components included in the packaging

The warranty does not cover damage caused by:

Accident or unanticipated events (e.g. lightning, water, fire)

Improper use or transport

Disregard of the safety and maintenance instructions

Other improper treatment of modification

After the expiration of the warranty period, you still have the possibility to have your product repaired at your own expense. If the repair or the estimate of costs is not free of charge you will be informed accordingly in advance.

This warranty does not limit the statutory obligation of the seller arising from a warranty. The period of warranty can only be extended in accordance with a legal standard. In countries where a (compulsory) warranty and/or spare part storage and/or a system for compensation are/is required by law, the statutory minimum conditions apply. In the event that a product is received for repair, neither the service company nor the seller will assume any liability for data or settings possibly stored on the product by customer.

Index

- 02 Introduction
 - 02 Certifications
 - 02 Publisher of the User Manual
 - 02 Manufacturer of the Infrared Quartz Heater
- 03 Product Components
- 04 Table of Contents
- 05 Chapter 1 - General Information
 - 05 Use and Storage of the User Manual
 - 05 Intended Use
 - 05 Emphasis Used
- 06 Chapter 2 - Safety
 - 06 Explanation of Symbols
 - 06 Electric Power
 - 06 3 Prong Grounding Plug
 - 07 Important Safety Instructions
- 09 Chapter 3 - Installation
 - 09 Unit
 - 09 Remote Control
- 10 Chapter 4 - Use
 - 10 Control Panel
 - 11 Before Use
 - 11 Operation
 - 11 Setting the Power Off Timer Function
 - 12 Setting the Power On Timer Function
- 13 Chapter 5 - FAQ
 - 13 Troubleshooting
 - 13 Cleaning
 - 13 Maintenance and Storage
 - 14 Technical Data
 - 14 Environmental Protection
- 15 Warranty Conditions
 - 15 Limited Warranty
 - 15 Limitations of Remedies and Exclusions
- 17 Warranty Card

MC Appliance
940 N. Central Avenue,
Wood Dale, IL 60191, USA
cshelp@mcappliance.com